

NKXR35-XL

Needle roller/axial cylindrical roller bearing

Schaeffler Kimliği:
0507807780000

Needle roller/axial cylindrical roller bearings NKXR, axial component, single direction, to DIN 5429, without end cap, for oil lubrication

X-life

Teknik bilgiler

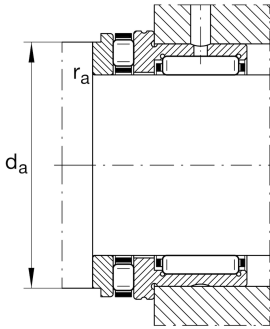
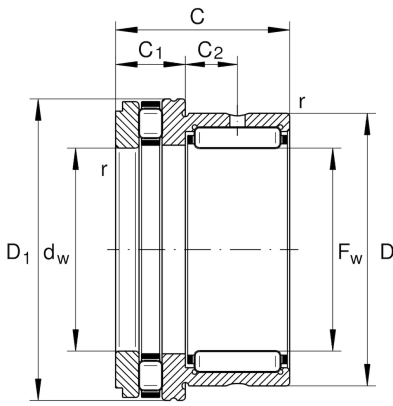

Dimensions

$D_{1\max}$	52,1 mm	Maximum outside diameter flange
$D_{2\max}$	52,1 mm	Maximum outside diameter flange
C_1	12 mm	Width of the axial bearing component
C_2	9 mm	Distance to lubrication hole
d_w	35 mm	Bore diameter of shaft washer
r_{\min}	0,6 mm	Minimum chamfer dimension
	154,93 g	Ağırlık

Main Dimensions & Performance Data

F_w	35 mm	Bore diameter
D	47 mm	Outside diameter
C	30 mm	Height
C_r	27.500 N	Basic dynamic load rating, radial
C_{0r}	41.500 N	Basic static load rating, radial
C_a	39.000 N	Basic dynamic load rating, axial
C_{0a}	101.000 N	Basic static load rating, axial
C_{ur}	7.400 N	Fatigue load limit, radial
C_{ua}	9.600 N	Fatigue load limit, axial
n_G	6.500 1/min	Limiting speed
$n_{\vartheta r}$	2.500 1/min	Reference speed

Mounting dimensions

d_a	47,7 mm	Mounting dimension shaft shoulder
$r_{a\max}$	0,6 mm	Maximum recess radius

Additional information

IR30X35X20-XL

Suitable inner rings IR

Temperature range

T _{min}	-30 °C	Operating temperature min.
T _{max}	120 °C	Operating temperature max.