

NKX60-Z-XL

Needle roller/axial ball bearing

Schaeffler Kimliği:
0507476490000

Needle roller/axial ball bearings NKX...-Z, axial component, single direction, to DIN 5429, with end cap, for grease lubrication

X-life

Teknik bilgiler

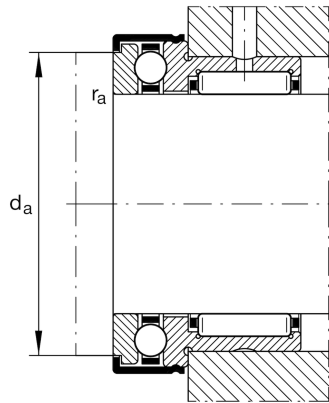
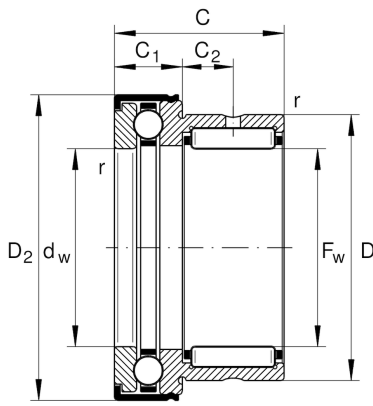

Dimensions

$D_{1\max}$	86,5 mm	Maximum outside diameter flange
$D_{2\max}$	86,5 mm	Maximum outside diameter flange
C_1	17 mm	Width of the axial bearing component
C_1	12 mm	Distance to lubrication hole
C_2	12 mm	Distance to lubrication hole
d_w	60 mm	Bore diameter of shaft washer
r_{\min}	1 mm	Minimum chamfer dimension
	454,6 g	Ağırlık

Main Dimensions & Performance Data

F_w	60 mm	Bore diameter
D	72 mm	Outside diameter
C	40 mm	Height
C_r	47.500 N	Basic dynamic load rating, radial
C_{0r}	90.000 N	Basic static load rating, radial
C_a	41.500 N	Basic dynamic load rating, axial
C_{0a}	113.000 N	Basic static load rating, axial
C_{ur}	15.600 N	Fatigue load limit, radial
C_{ua}	5.600 N	Fatigue load limit, axial
n_G	2.800 1/min	Limiting speed

Mounting dimensions

d_a	80,5 mm	Mounting dimension shaft shoulder
$r_{a\max}$	1 mm	Maximum recess radius

Additional information

IR50X60X25-XL

Suitable inner rings IR

Temperature range

T _{min}	-30 °C	Operating temperature min.
T _{max}	120 °C	Operating temperature max.