

HK4518-RS

Drawn cup needle roller bearing open end

Schaeffler Kimliği:
0002563310968

Drawn cup needle roller bearings with open ends HK..-RS, lip seal on one side, to DIN 618

Teknik bilgiler

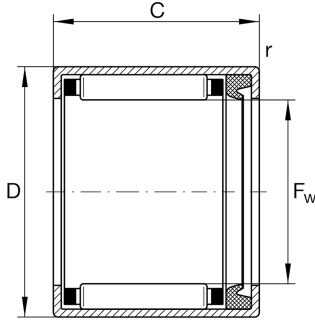

Dimensions

C_1	18 mm	Width, outer ring
r_{min}	0,8 mm	Minimum chamfer dimension
	44,875 g	Ağırlık

Main Dimensions & Performance Data

F_w	45 mm	Under roller diameter
D	52 mm	Outside diameter
C	18 mm	Width
C_r	21.300 N	Basic dynamic load rating, radial
C_{0r}	43.000 N	Basic static load rating, radial
C_{ur}	5.800 N	Fatigue load limit, radial
n_G	3.550 1/min	Limiting speed
$n_{G Grease}$	3.550 1/min	Limiting speed for grease lubrication

Additional information

LR40X45X20,5	Suitable inner rings LR
IR40X45X20-XL	Suitable inner rings IR

Temperature range

T_{min}	-20 °C	Operating temperature min.
T_{max}	100 °C	Operating temperature max.