

HK4018-RS

Drawn cup needle roller bearing open end

Schaeffler Kimliği:
0006831160968

Drawn cup needle roller bearings with open ends HK..-RS, lip seal on one side, to DIN 618

Teknik bilgiler

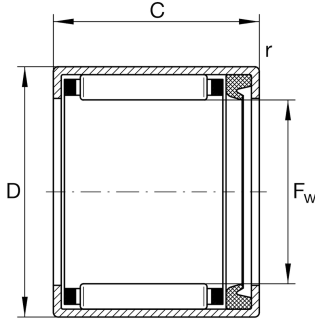

Dimensions

C_1	18 mm	Width, outer ring
r_{min}	0,8 mm	Minimum chamfer dimension
	44,925 g	Ağırlık

Main Dimensions & Performance Data

F_w	40 mm	Under roller diameter
D	47 mm	Outside diameter
C	18 mm	Width
C_r	20.000 N	Basic dynamic load rating, radial
C_{0r}	38.500 N	Basic static load rating, radial
C_{ur}	5.100 N	Fatigue load limit, radial
n_G	3.950 1/min	Limiting speed
$n_{G Grease}$	3.950 1/min	Limiting speed for grease lubrication

Additional information

LR35X40X20,5	Suitable inner rings LR
IR35X40X20-XL	Suitable inner rings IR

Temperature range

T_{min}	-20 °C	Operating temperature min.
T_{max}	100 °C	Operating temperature max.