

## HK4016-2RS

Drawn cup needle roller bearing open end

Schaeffler Kimliği:  
0002563230968

Drawn cup needle roller bearings with open ends HK..-2RS, lip seals on both sides, to DIN 618

### Teknik bilgiler

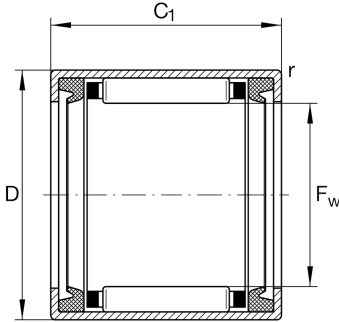

#### Dimensions

$C_1$	16 mm	Width, outer ring
$r_{min}$	0,8 mm	Minimum chamfer dimension
	37 g	Ağırlık

#### Main Dimensions & Performance Data

$F_w$	40 mm	Under roller diameter
$D$	47 mm	Outside diameter
$C$	16 mm	Width
$C_r$	14.000 N	Basic dynamic load rating, radial
$C_{0r}$	24.300 N	Basic static load rating, radial
$C_{ur}$	3.250 N	Fatigue load limit, radial
$n_G$	3.950 1/min	Limiting speed
$n_{G Grease}$	3.950 1/min	Limiting speed for grease lubrication

#### Additional information

LR35X40X16,5	Suitable inner rings LR
IR35X40X17-XL	Suitable inner rings IR

#### Temperature range

$T_{min}$	-20 °C	Operating temperature min.
$T_{max}$	100 °C	Operating temperature max.