

HK2520-2RS

Drawn cup needle roller bearing open end

Schaeffler Kimliği:
0007000530968

Drawn cup needle roller bearings with open ends HK..-2RS, lip seals on both sides, to DIN 618

Teknik bilgiler

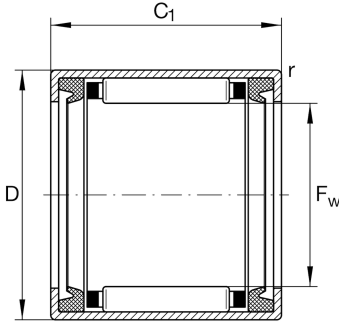

Dimensions

C_1	20 mm	Width, outer ring
r_{min}	0,8 mm	Minimum chamfer dimension
	30,78 g	Ağırlık

Main Dimensions & Performance Data

F_w	25 mm	Under roller diameter
D	32 mm	Outside diameter
C	20 mm	Width
C_r	15.600 N	Basic dynamic load rating, radial
C_{0r}	24.000 N	Basic static load rating, radial
C_{ur}	3.200 N	Fatigue load limit, radial
n_G	6.100 1/min	Limiting speed
$n_{G Grease}$	6.100 1/min	Limiting speed for grease lubrication

Additional information

LR20X25X20,5	Suitable inner rings LR
IR20X25X20-XL	Suitable inner rings IR

Temperature range

T_{min}	-20 °C	Operating temperature min.
T_{max}	100 °C	Operating temperature max.